

**Technowood®**

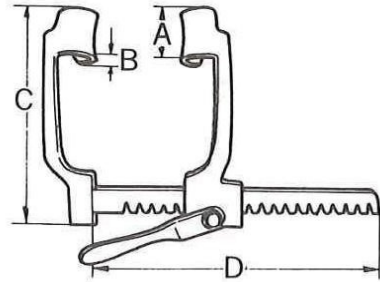

**CARDIOTHORACIC SURGERY  
INSTRUMENTS**

## SAKAKIBARA RIB SPREADER

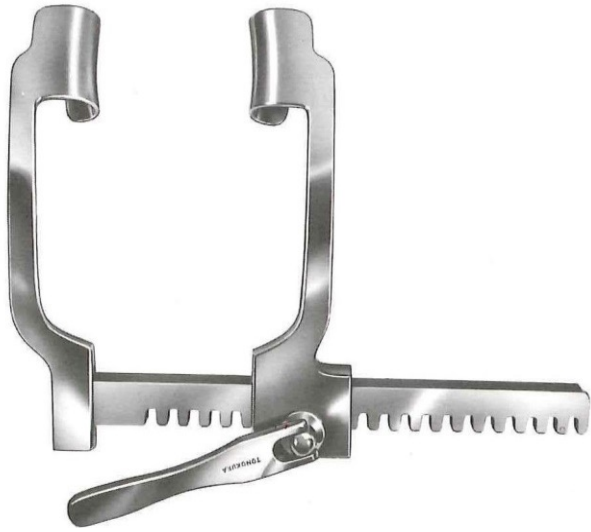

| Catalog No | A cm | B cm | C cm | D cm |
|------------|------|------|------|------|
| 25-30-L    | 4    | 3    | 19   | 23   |
| 25-30-M    | 3    | 2.5  | 18   | 23   |
| 25-30-S    | 2    | 2.3  | 17   | 22   |

## SAKAKIBARA PEDIATRIC RIB SPREADER

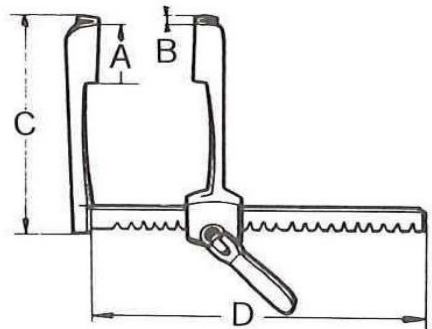
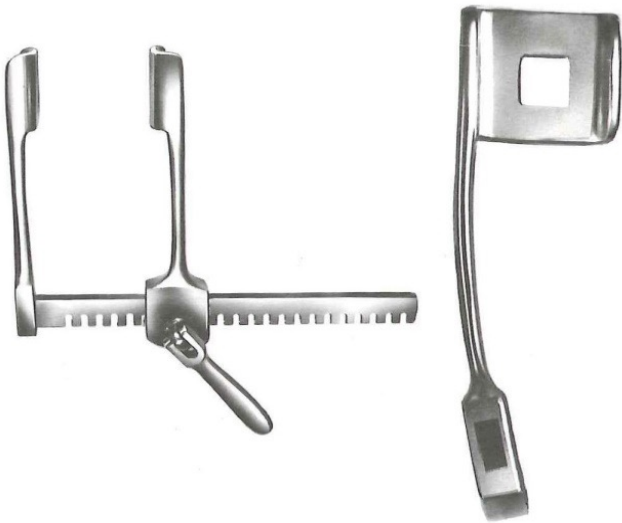

| Catalog No | A cm | B cm | C cm | D cm |
|------------|------|------|------|------|
| 25-33-L    | 2.5  | 2.3  | 10   | 13   |
| 25-30-S    | 2    | 1.5  | 7.5  | 13   |

## MODIFIED SAKAKIBARA RIGHT ANGLE FORCEPS

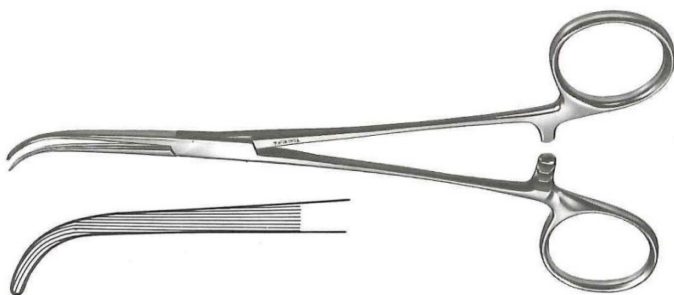

| Catalog No | Size  | Length (cm) |
|------------|-------|-------------|
| F02-27-L   | Large | 21.0        |
| F02-27-S   | Small | 16.0        |

## DISSECTING FORCEPS

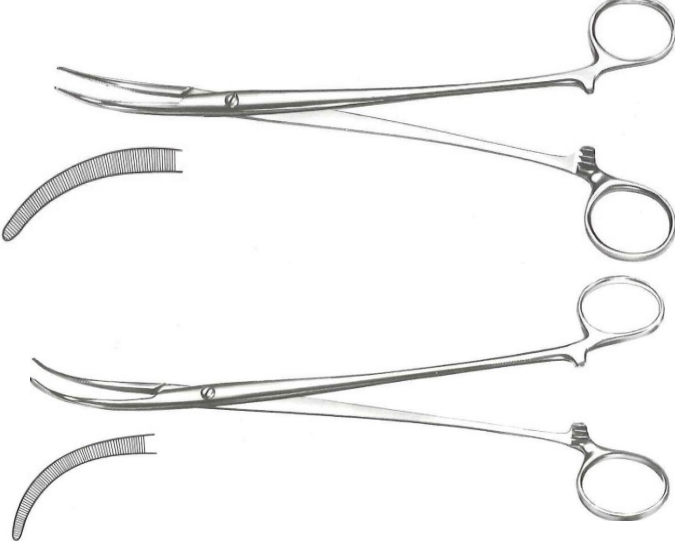
|  | Developed by the Tuberculosis Research Institute (Japan) |                                 |             |
|---|--|---------------------------------|-------------|
|   | Catalog No   | Tip                             | Length (cm) |
|   | 02-04-22   | Vascular Kelly type fine curve  | 22.0        |
|   | 02-06-04   | Bronchus Kelly type sharp curve | 16.0        |

## LUNG DISSECTING FORCEPS

|  | Developed by the Tuberculosis Research Institute (Japan) |             |
|---|--|-------------|
|   | Catalog No   | Length (cm) |
|   | S04632202F0001   | 22 curved   |

## STERNAL WIRE FORCEPS

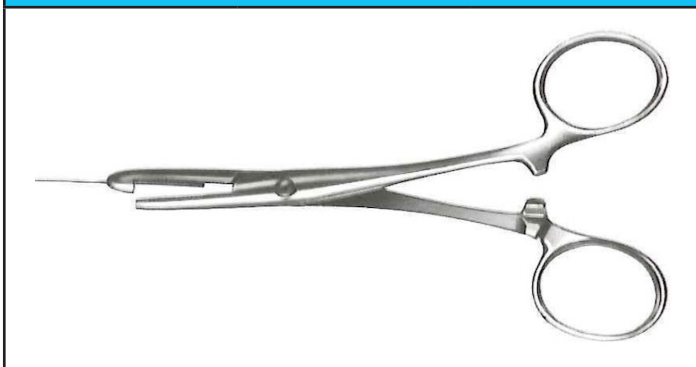

| Catalog No | Max wire size | Length cm |
|------------|---------------|-----------|
| 344BH13    | 1.00mm        | 16        |

## MOSQUITO HEMOSTATIC FORCEPS



| Catalog No     | Tip          | Length |
|----------------|--------------|--------|
| S01041100B0001 | non serrated | 11     |

## AORTIC VALVE RETRACTOR

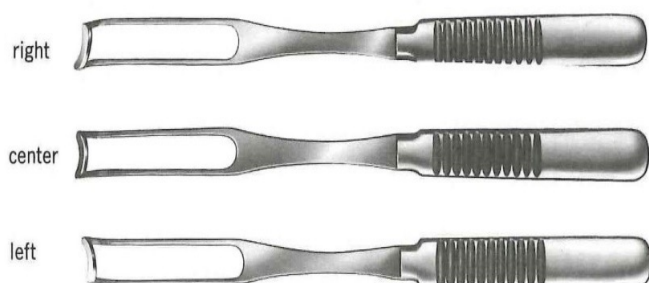

## MITRAL VALVE RETRACTOR

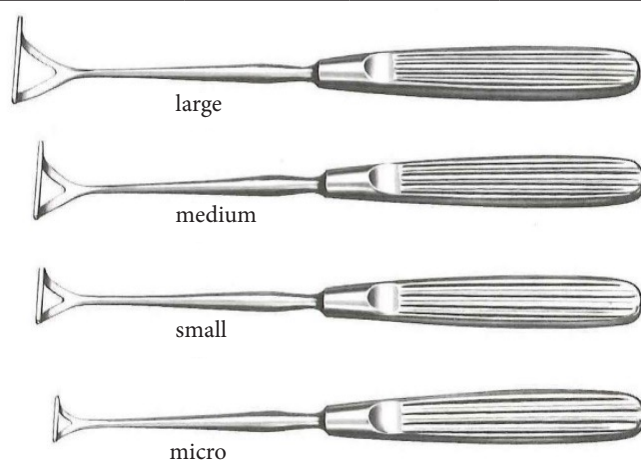

| Catalog No | Type   | Length cm | Hook width cm | Catalog No | Type   | Length cm | Hook width cm |
|------------|--------|-----------|---------------|------------|--------|-----------|---------------|
| 344K1      | right  | 22.5      | 1.4           | 344K10     | Large  | 22        | 2.8           |
| 344K2      | center | 22.5      | 1.4           | 344K9      | Medium | 22        | 2.2           |
| 344K3      | left   | 22.5      | 1.4           | 344K8      | Small  | 22        | 1.8           |
|            |        |           |               | 344K7      | Micro  | 22        | 1.5           |

## CARDIAC TWEEZERS

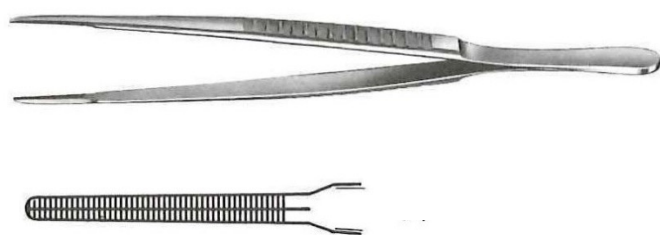

## FALLOT TWEEZERS

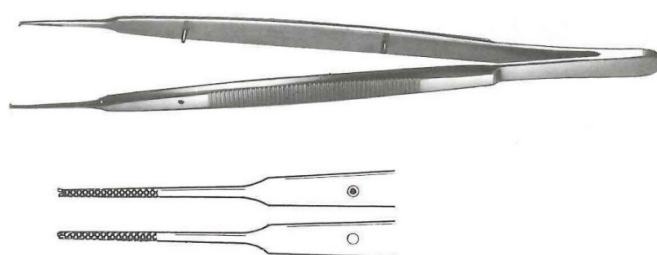

| Catalog No | Type   | Length cm | Catalog No | Tip          | Length |
|------------|--------|-----------|------------|--------------|--------|
| 344S20     | Cooley | 20        | 32-11-20   | non serrated | 20     |
| 344S24     | Cooley | 24        |            |              |        |

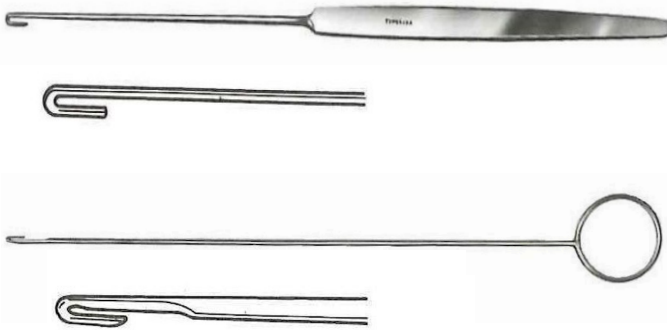
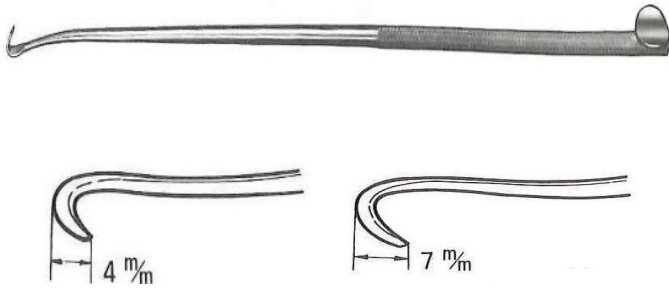
| SUTURE/TAPE THREADER  |           | SURGICAL HOOK AND SPOON  |           |        |
|---|-----------|--|-----------|--------|
|  |           |  |           |        |
| Catalog No  | Length cm | Catalog No   | Tip cm    | Length |
| 30-05   | 25.0      | 03-2602  | 0.4 short | 27.5   |
| 30-06-20  | 22.0      | 03-2603  | 0.7 long  | 27.5   |

| SUTURE HOOK   |            |           |
|---|------------|-----------|
|  | Catalog No | Length cm |
|   | 23-28      | 20.0      |



# Technowood®

[www.technowood.co.jp](http://www.technowood.co.jp)

## *JAPAN*

### **Technowood Corporation**

Tel: +81 (3) 3856-4111

Fax: +81 (3) 3856-4113

## *USA*

### **Technowood America Corporation**

Tel: +1 (714) 434-8713

Fax: +1 (714) 434-8715

## *INTERNATIONAL*

### **Technowood International Pte. Ltd.**

Tel: +81 (3) 3898-5252

Fax: +81 (3) 3898-5252



Please refer to the Instructions For Use for details.  
Terms and conditions may change without prior notice.

BS2303R0